

scanomat®

Pure Coffee

User's manual



Compact One

English edition.

Re-ordering No: 2000668
Version: 2

We are pleased that you have chosen a Scanomat Coffee Brewer.

Should you have any questions regarding the coffee brewer and the operation of it please do not hesitate to contact us.

We are convinced that you will be pleased with your choice!

Vibe Allé 3 • Postboks 131 • 2980 Kokkedal
Telefon 49 18 18 00 • Telefax 49 18 01 18

Important

Warning:

Please be aware of the danger of scalding (in the dispensing area) when dispensing the various hot drinks.

Warning:

Before cleaning, servicing etc. that require the opening of the front door, the switch situated in the delivery area must be switched off. The brewer has been switched off when the display light turns off and the blower stops.

Note:

Please be aware that the switch only disconnects control circuit, **not** the power supply.

Contents

Operation of the SCANOMAT Coffee Brewer	1
Technical Specifications:	2
General Drawing	3
Installation	4
Water Connection	5
The display of the coffee brewer	6
The keyboard of the coffee brewer	8
Initial start up of the coffee brewer	10
Normal use	12
Brewing cups:	12
Pre-selections:	12
Brewing carafes:	12
Strong:	12
Light:	13
Decaf:	13
Cold:	14
Setting / programming of the coffee brewer	15
On/Off:	15
Temperature:	16
Adjusting the individual selections:	16
Cup size:	17
Strength:	17
Direct carafe selection:	18
Price:	18
Carafe sizes:	19
Timer functions:	20
Adjusting blocked drinks in timer function 3:	22
Adjusting time format:	23
Adjusting the active recipe version:	23
Service functions	24
Reading out the counters:	24
Erasable counters:	25
Resetting counters	25
Reading out the not erasable counters	25
Print out of the counters:	26
Print out of the setting of the coffee brewer:	26
Product weighing:	27
Maintenance	28

Daily Maintenance:	28
Preventive Maintenance	29
Trouble Shooting:	30
Connection Chart Compact One	31

Operation of the SCANOMAT Coffee Brewer

The Scanomat coffee and coffee speciality brewers are high technology brewers which by means of a micro processor controlled brew process dispense various first class quality coffee drinks.

Water is heated in the thermostatically controlled hot or cold-water tank with automatic water inlet. The water tank has built-in over-heaters and an overflow leading to the drip tray.

By means of an ingredient throw device the various instant products are led from the canisters to a brew chamber and here water is added. If necessary, the ingredients could be stirred mechanically in the brew chamber before the drink in question is led to the outlet spout. It is possible to choose between cup or jug dispensing.

Technical Specifications:

Power supply:

230 VAC single phase with ground connection, or 400 VAC 2 phases with neutral and ground connection (Idle power consumption approx. 20 watt).

Dimension:

Height: 67 cm

Width: 26 cm

Depth: 30 cm

Water tank:

Hot water tank capacity: 6 litres

Weight:

Gross 24 kg

Nett 22 kg

Water connection:

2 - 6 Kp/cm², flow min. 3-5 l./min.

Water temperature: 5 - 12°C.

Environment:

Temperature: 10 - 40°C, humidity max. 90%RH.

Shelves/transportation:

Temperature: min. 0°C.

General Drawing

- A. Ingredient canister
- B. Ingredient funnel
- C. Mixer bowl
- D. Whipper tray
- E. Outlet hose
- F. Outlet holder
- G. Whipper tray
- H. Drip tray
- I. Main switch
- J. Quality Key reader (optional)
- K. Cover plate
- L. Service switch
- N. Mixer lid
- O. Whipper blade
- P. Cup mesh
- Q. Cup holder
- R. Outlet tube (optional)
- T. Mesh
- U. Levelling legs

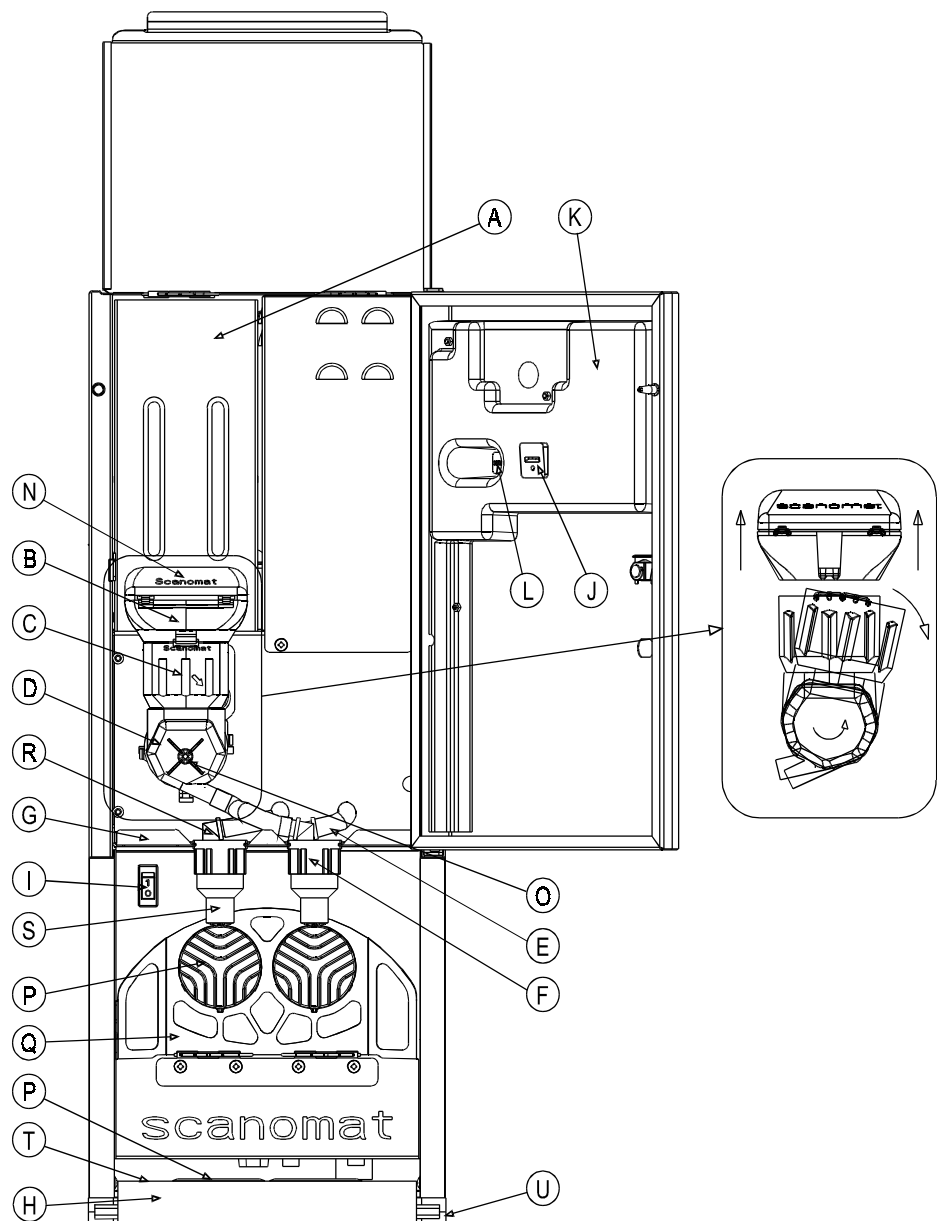

Installation

Service and repair is only to be carried out by service engineers educated by Scanomat.

The coffee brewer is to be secured additionally in accordance with regulations.

The coffee brewer must be earth connected (yellow/green conductor).

Note: If the supply cable (power cord) has been damaged please note that only a maintenance engineer recommended by the manufacturer is to renew it as special tools are required.

Earth conductor: yellow/green

Neutral conductor: blue

Phase: brown/black

Note: Place the coffee brewer on a stable table, adjust the levelling feet until the brewer is level from front to back and side to side. Be certain all four levelling feet are in contact with the table to prevent rocking of the brewer. If there is a danger of the brewer falling down from the table it must be bolted down to the table top (unscrew the levelling feet and fasten by screwing through the table top).

Note: The coffee brewer require ventilation. Therefore there must be a minimum of 50 mm from the back side of the brewer to the wall. The grating must be inspected frequently and vacuum-cleaned. If the installation site/environment is especially dusty there must be vacuum-cleaned each month.

Note: Before connecting the coffee brewer draw off some buckets of water by means of the hose (to clean the pipes and to avoid a disagreeable taste). This procedure is also recommended when the brewer has not been operating for some time.

Note: We recommend that the brewer is switched on permanently due to the ventilation system among others.

Water Connection

When the water supply is being established please make sure that the coffee brewer is not situated on the rear end of the water supply system to ensure continuous supply of fresh water (see illustration below).

1. Connect the coffee brewer to the cold water line which is equipped with an adjustable check valve (1/2" external screw thread G+F). Before connecting the brewer draw off some buckets of water to clean the pipes.
If the water quality is not top-quality we recommend that a Scanomat water filter is mounted.
2. Fasten the hose nipple (C) with screws to the connecting nipple (B) (available in angle and straight version).
3. The connecting nipple is to be screwed on to the valve at the bottom of the coffee brewer.
4. Dirt filter (E) and nipple (D) are to be mounted.
5. The flange of the hose (C) is to be mounted on the nipples (D) and (B).
6. Turn on the water and make sure that all joints and connections are tight.

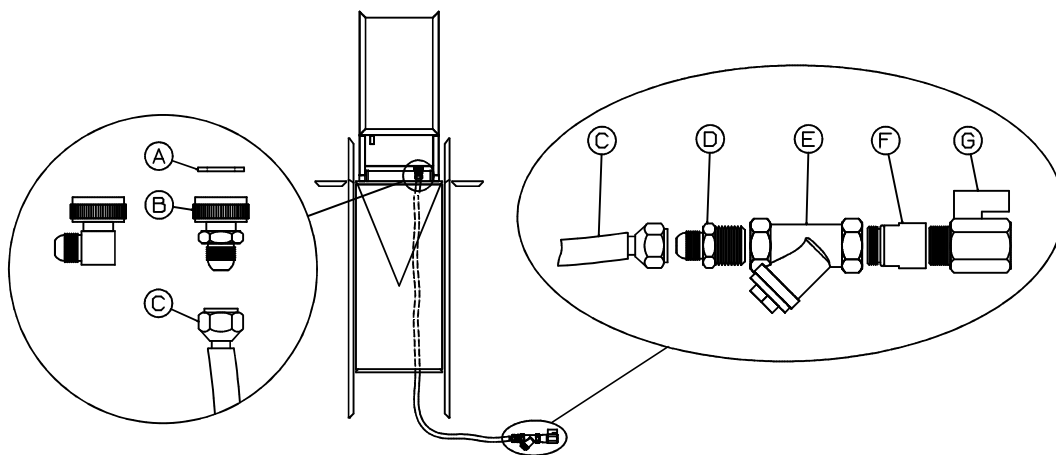

Note

If the water has a disagreeable taste when heated we recommend that the heated water is drawn off the brewer and let the brewer take in water anew.

After holidays or weekends when the brewer has not been in operation for some time the water will loose on quality therefore we recommend activating the "**clean programme**", perhaps a couple of times, in order to get fresh water. In special cases it could be necessary to empty the water tank completely by means of the drain hose and then let the brewer take in fresh water. This operation could be repeated if necessary.

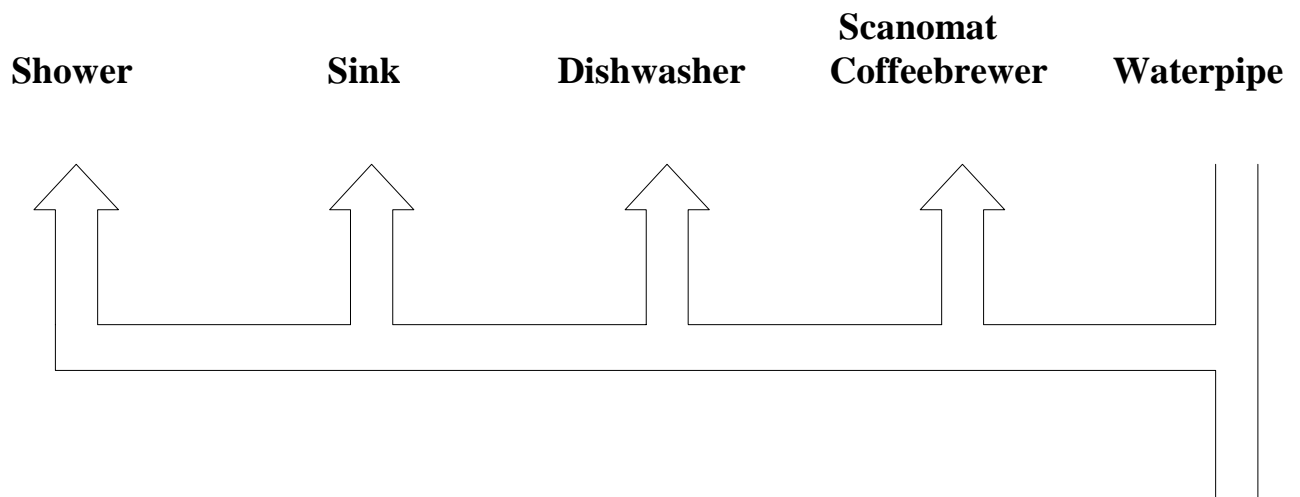

The display of the coffee brewer

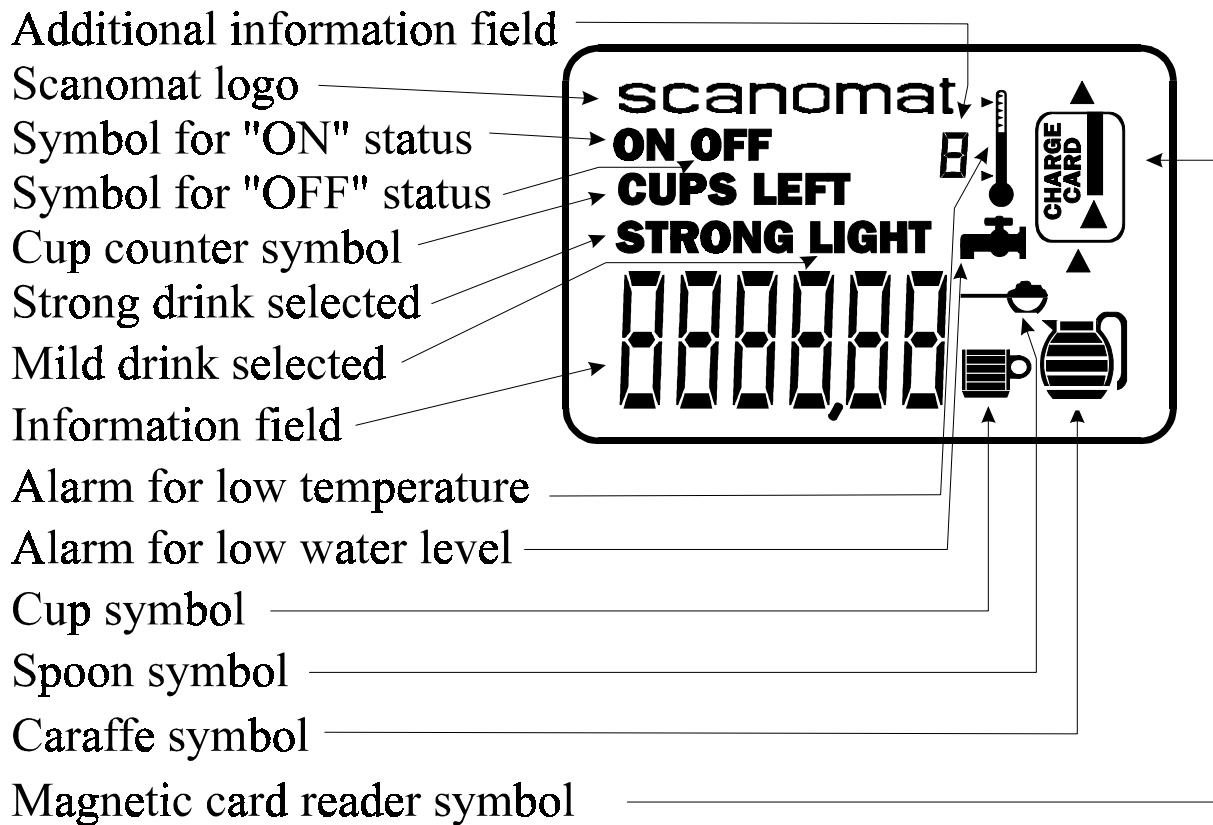

Explanation of the individual symbols in the display.

- ON** Shows that the coffee brewer is in normal operating status. The symbol is also used during programming of the timers.
- OFF** Shows that the coffee brewer has been switched off either by means of the keyboard or by one the programmable timers. No drinks can be brewed.
- CUPS** Used when reading out the counters and when adjusting the carafe sizes.
- STRONG** Shows that a strong drink has been selected.
- LIGHT** Shows that a light (mild) drink has been selected.
- INFORMATION FIELD** Used to display temperature and functions, which do not have fixed symbols.

Temperature display:

Coffee brewers with only hot water:

When the heating element is active, there will be a flashing “H” in front of the temperature.

Coffee brewers with only ice water:

When the cooling compressor is active, there will be a flashing “C” in front of the temperature.

Coffee brewers with as well hot as ice water:

When the hot water temperature is on the display, there will be a “H” in front of it. If the heating element is active, the “H” will be flashing.

When the ice water temperature is on the display, there will be a “C” in front of it. If the cooling compressor is active, the “C” will be flashing.

WATER VALVE Will be active if the water tank is not completely full. In this situation, pressing a selection key will cause the coffee brewer to take in water thereby filling the tank completely before starting the brew. If the tank can not be filled within 5 seconds, the brew will not be made.

Will be flashing if the level in the water tank is critically low. In this situation no drinks can be made and the heating element will be disabled. Pressing a selection key will cause the coffee brewer to attempt to take in water for a maximum time of 3 minutes. If this is not enough to fill the tank the key press must be repeated

THERMO METER Will be flashing if the temperature in the hot water tank is too low. No drinks can be selected in this situation.

CUP Will be flashing during brew. Also used to indicate the size of the cup during adjusting this.

CARAFFE Will be on when a carafe is pre-selected.

ADDITIONAL INFO Used during programming of timers.

MAGNETIC CARD Used during reading magnetic keys: - CREDIT KEY and QUALITY KEY.

The keyboard of the coffee brewer

Explanation of the individual keys:



Selection key. Pressing this when the coffee brewer is in normal operating state will cause this to make a brew.



Carafe pre-selection. Pressing this will cause the following selection to be made in a multiply according to setting of this carafe.



Will activate the pre-selection STRONG. This will make the following selection stronger than standard.



Will activate the pre-selection LIGHT (mild) . This will cause the following drink to be milder than standard.



Will activate the pre-selection DECAF. This will cause the following drink to be made with DECAF coffee in stead of normal. During programming this key is used to increase values.



Will activate the pre-selection COLD: This will cause the following drink to be made with cold water in stead of hot. During programming this key is used to decrease values.

The two above mentioned keys have during programming an automatic repeat function. This means that keeping one of these pressed during adjusting a value, this will change automatically.



Will display the watch of the coffee brewer.



Used to switch the coffee brewer on and off.



Used to read out information from the coffee brewer.



Used to confirm settings during programming of the coffee brewer.



Used to adjust the active recipe version of the coffee brewer.



Used to interrupt an ongoing carafe brew, an ongoing cleaning sequence or to stop a programming function.



Used during programming of the coffee brewer.



Activates the cleaning program of the coffee brewer.





Used during programming to select next value.





Used to activate / deactivate the SERVICE program of the coffee brewer.

NOTE:

Not all keys mentioned here will be active in all coffee brewers. For example the keys  and . These will only be active if the coffee brewer is equipped with DECAF coffee and COLD water system respectively. The availability of individual keys is also dependant on the customer related setting of the coffee brewer.



Initial start up of the coffee brewer

- 1) Set the On/Off switch in the brewing region to On = 1. There will be light in the display of the coffee brewer.

When the coffee brewer has been connected to power and water, it will for safety reasons not automatically take in water. The display will show a flashing , a flashing  and a low temperature.

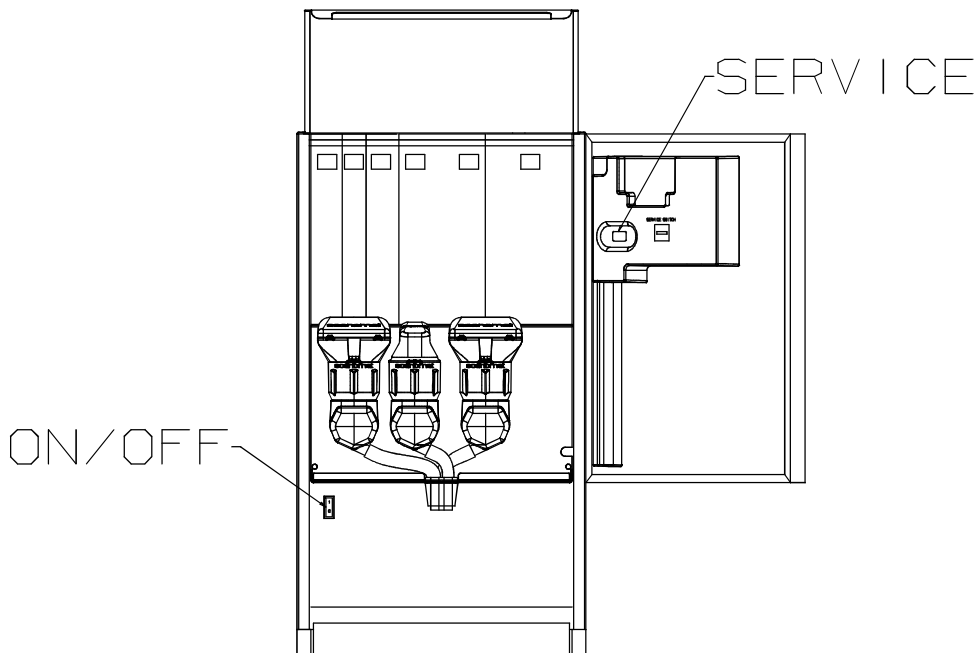
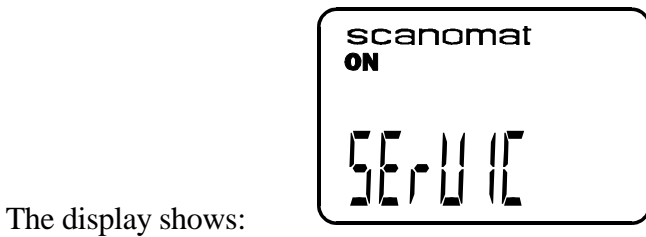
- 2) Activate the SERVICE program by pressing , which is placed on the inside of the door.



- 3) Press , and the coffee brewer will start taking in water for a maximum of 3 minutes. If the water supply pressure is low, this might not be enough to fill the water tank. This will be indicated by the flashing  on the display. Press  to repeat the process.

When the water tank is full, the heating element will be activated and heat the water to the programmed temperature. When this is reached, the coffee brewer is ready for test.

- 4) Fill the ingredient bins of the coffee brewer.

- 5) As the products need to be brought forward to the end of the augers before a correct dosage can be obtained, the following test procedure is recommended:
- a) Place a carafe under the outlet(s).
 - b) Activate all the different selections one by one to make sure, that all product augers have been active.

The coffee brewer is now ready for use.

Normal use

Brewing cups:

During normal use, a cup is dispensed by placing a cup or a mug under the outlet spout and press the appropriate selection key. If the coffee brewer is equipped with more than one outlet spout, there will be an indication showing which selection goes to which spout.

Pre-selections:

Brewing carafes:

When brewing carafes first select the desired size by pressing ,  or .

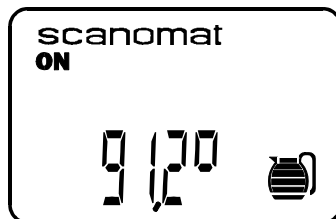

The display will show:

Pressing a selection key will now cause the dispensing of the number of cups programmed for the selected carafe size.

Pressing  will cause the coffee brewer to stop the carafe brew after completing the ongoing cup.

The pre-selection carafe is cancelled if  is pressed.
The pre-selection carafe is cancelled automatically after 15 seconds if no selection key is pressed.
The pre-selection carafe is cancelled automatically after the brewing.

Strong:

Pressing  will activate the pre-selection STRONG.

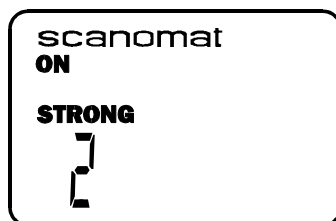

The display will show:

(after 2 times pressing )

The following drink will now be made 2 steps stronger than normal. The function STRONG is in 5 steps. Each press on  will increase the value by 1, which will be indicated in the display.

The pre-selection STRONG is cancelled if  is pressed.
 The pre-selection STRONG is cancelled automatically after 15 seconds if no selection key is pressed.
 The pre-selection STRONG is cancelled automatically after the brewing.

Light:

Pressing  will activate the pre-selection LIGHT (mild).

The display will show:

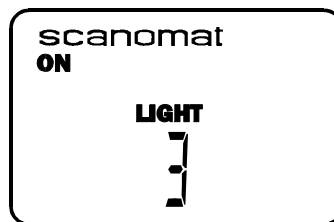

(after 3 times pressing )

The following drink will now be made 3 steps lighter than normal. The function LIGHT in 5 steps. Each press on  will increase the value by 1, which will be indicated in the display.

The pre-selection LIGHT is cancelled if  is pressed.
 The pre-selection LIGHT is cancelled automatically after 15 seconds if no selection key is pressed.
 The pre-selection LIGHT is cancelled automatically after the brewing.

Regarding the pre-selections STRONG and LIGHT with respect to mixed drinks, only the taste dominating product will be adjusted. In for CAPPUCCINO, only the amount of coffee will be adjusted. For further details of the influence of STRONG / LIGHT on the individual selections, refer to the print out of the recipes.

Decaf:

Pressing  will activate the pre-selection DECAF.

The display will show:



The following drinks will now be brewed of decaffeinated coffee in stead of normal. This also goes for any mixed drinks containing a coffee product.

The pre-selection DECAF is cancelled if  is pressed.

The pre-selection DECAF is cancelled automatically after 15 seconds if no selection key is pressed.

The pre-selection DECAF is cancelled automatically after the brewing.

Note:

The coffee brewer must be equipped with a decaffeinated coffee, to make this option available. The individual selections in the recipes can be composed in a way not allowing the user to freely select between normal and decaffeinated coffee. For further details on this refer to the print out of the recipes.

Cold:

Pressing  will activate the pre-selection COLD. The display will show:

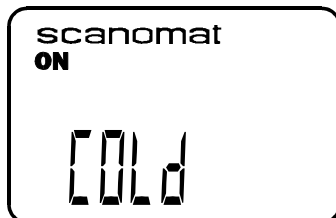

The following drink will now be made with cold water in stead of hot.

The pre-selection COLD is cancelled if  is pressed.

The pre-selection COLD is cancelled automatically after 15 seconds if no selection key is pressed.

The pre-selection COLD is cancelled automatically after the brewing.

Note:

The coffee brewer must be equipped with a cold water system, to make this option available. The individual selections in the recipes can be composed in a way not allowing the user to freely select between cold an hot water. For further details on this refer to the print out of the recipes.

Setting / programming of the coffee brewer

All functions in this section requires, the coffee brewers SERVICE program is active. This is activated by pressing the  key positioned on the inside of the door of the coffee brewer. The display will show:

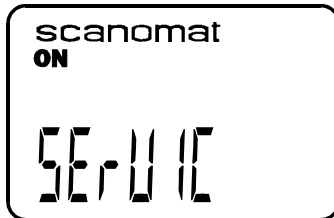

Note:

The coffee brewer can be set up to automatically leave the SERVICE program, if no key has been activated for a period of 15 seconds.

The coffee brewer can be set up in a way, that the  key is not active. In this case the SERVICE program is activated by pressing a code on the keyboard. This code is available from Your Scanomat dealer.

On/Off:

There are two ways to turn the coffee brewer off:

- 1) You can set the On/Off switch in the brewing region to 0. This will cut the power to the control system of the coffee brewer thus turning this completely OFF.
- 2) You can turn the coffee brewer off by means of the  key on the keyboard. This will disable the keyboard of the coffee brewer, switch off the light in the display and reduce the temperature in the hot water tank by approximately 25°C. (The latter is dependant on the setting of the actual machine). This way of switching the coffee brewer off has the advantage, that it will be ready for use, as soon as it is switched on again.

With the SERVICE program active - press  and the display will show:

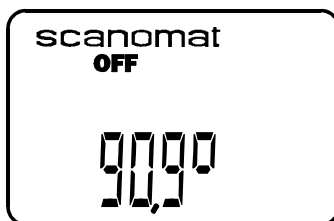

(Lights off)

The coffee brewer can be switched on again by activating the SERVICE program and pressing









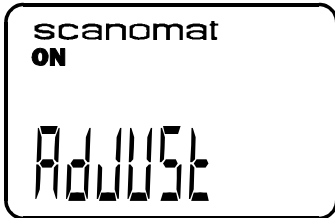

Temperature:

The hot water temperature of the coffee brewer can be adjusted as follows:

- a) Press  while the SERVICE program is active. The display will show:



- b) Press  and the display will show the currently selected temperature. Press  and  to adjust this up and down respectively. Press  to accept the new value.
- c) The program will now show the currently selected temperature CELCIUS or FAHRENHEIT.
- d) Press  to  change this setting or  to skip this adjustment.
- e) Press  to accept the new value.

Note: The possibility to adjust temperature is optional.

Adjusting the individual selections:

The individual selections can be adjusted with respect to cup size and maybe strength, direct carafe size and price. These adjustments are a sequence in the program, which means, that You have to go through the first adjustments to reach the later. If an adjustment should not be changed, simply press  when this is on the display, and the program will proceed to the next adjustment in the sequence. The Sequence of the adjustments is as follows:

Cup size
 [Strength]
 [Direct carafe selection]
 [Price]

The adjustments in brackets are optional and will therefor not be available in all coffee brewers.

Cup size:

- a) Press  while the SERVICE program is active.



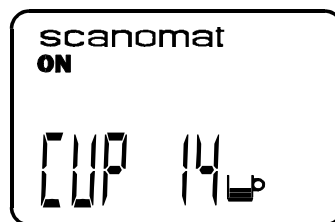

The display will show:

- b) Press the key for the selection to be adjusted and the display will now show the current setting for this:



14 being the current cup size

- c) Press  and  to adjust this up and down respectively. The size of one step is approximately 5 percent. The range is from 0 through 31. **Note: If the cup size is set to 0, the selection will be locked.**

- d) Press  to accept the value, and the program is now ready for adjusting strength.



Strength:

For mixed drinks, it is possible to adjust the strength for the individual components. The sequence of the product to be adjusted is the same as the sequence in the print out of the recipe.

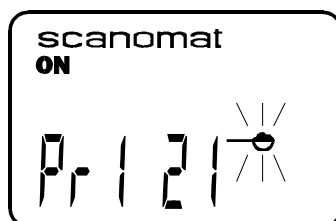
- a) After adjusting the cup size, the display will show:



21 being the current strength for product 1.

- b) Press  and  to adjust the amount for this product up and down respectively. The range for each product is 0 through 31. The size for each step for each product can be seen in the print out of the recipes. Press  to accept the new value, and the program will proceed to the next adjustable product until no more in this drink.



Direct carafe selection:

It is possible to program a selection key to be a direct carafe selection. This means, that pressing this selection key will cause the coffee brewer to dispense **a number of cups** of the selection in question. **This function is optional.**

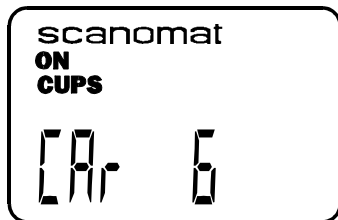
After adjusting the strength(s) the display will show:



6 cups being the currently selected carafe size.

- a) Press  and  to adjust the number of cups up and down respectively. If the number of cups is set to 0 or 1, pressing the selection key will cause the coffee brewer to make only one cup. In this case the display will show:

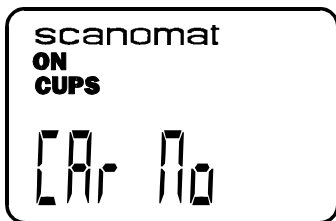



- b) Press  to accept the new value.

Price:

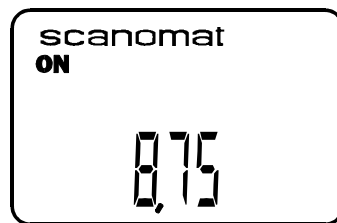
If the coffee brewer is set to run with a payment or accounting system the display will after making the above mentioned adjustments show:



8,75 being the current price for this selection.

- a) Press  and  to adjust the price up and down respectively. The steps for the price will normally be the smallest available coin. If the price is set to 0, the coffee brewer will dispense this selection for free.
- b) Press  to accept the new value.

All adjustments concerning this selection are now done.

Carafe sizes:

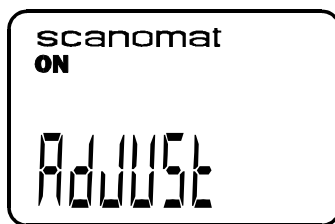

- a) Press  while the SERVICE program is active. The display will show:

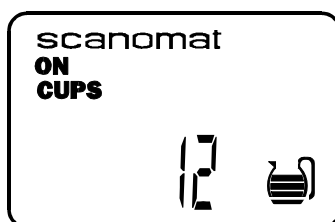

- b) Press the key for the carafe to be adjusted and the display will show:



12 being the current number of cups for this carafe.

- c) Press  and  to adjust the number of cups up and down respectively. The carafe size can be adjusted between 0 and 200 cups. If the size is set to 0 cups, nothing will be dispensed with this carafe as pre-selection. Note: it is possible to set the size of the individual carafes freely, thus enabling the small carafe to be bigger than the large one.
- d) Press  to save the new value.

Timer functions:





The coffee brewer is equipped with an internal watch. This can be used for programming the coffee brewer to different timer controlled actions.

- 1) To automatically switch off in programmed periods.
- 2) To automatically dispense free drinks in programmed periods (For coffee brewers with payment or accounting systems)
- 3) To automatically lock out selected drinks in programmed periods.

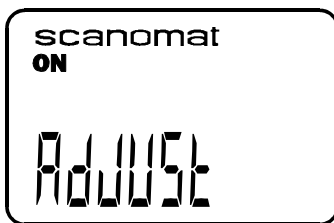

The coffee brewer has 5 programmable timer, which can be adjusted as follows:

- a) Press  while the SERVICE program is active. The display will show:







- b) Press  and the display will show the actual time with the minutes flashing.
- c) Press  and  to adjust these up and down respectively.
- d) Press  to accept this value (seconds will now be set to 0).

The display will now show the time with the hours flashing.

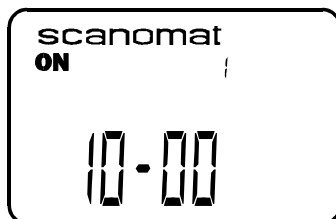



- e) Press  and  to adjust these up and down respectively.
- f) Press  to accept this value.

The display will now show the starting time for the first programmable timer with the minutes flashing:

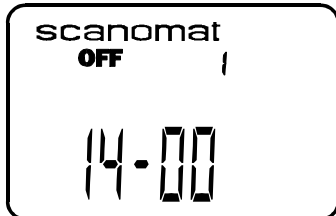

- g) This time can now be adjusted using ,  and  as described in point c to f. After pressing  the end time for this programmable timer with the minutes flashing will be on the display:



- h) This time can now be adjusted using ,  and  as described in point c to f. After pressing  the function for this will be on the display. There are 3 different timer functions available:

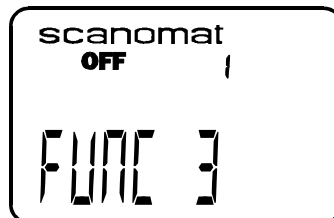
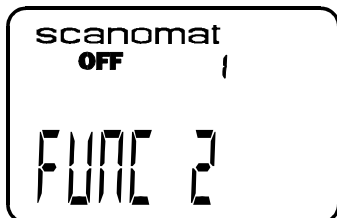
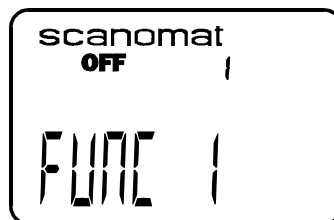
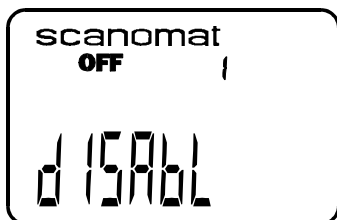

- i) Press  and  to select between the 3 functions and "disabl".

- "Disabl" Means that this timer is not active.
 "Func 1" Means that the coffee brewer will switch off in the programmed period.
 "Func 2" Means that the coffee brewer will dispense free drinks in this period (for coffee brewers with payment or accounting system).
 "Func3" Means that the coffee brewer will lock out individual drinks in the programmed period.

Adjusting blocked drinks in timer function 3:

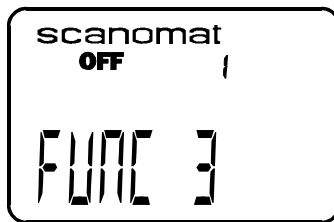

When the display shows

the individual selections can be enabled/locked in the following way:

a) Press a selection key, and the display will show the current status for this:

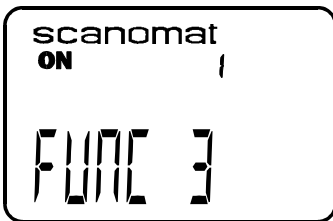

Means that the selection can be dispensed during the programmed period

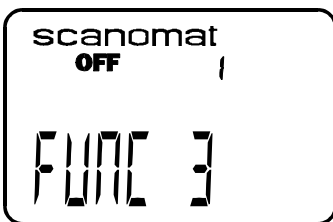



Means that the selection is locked during the programmed period

b) switching between the 2 functions is done by pressing 

After completing the setting for all selections this can be verified by pressing the selection buttons one by one and then controlling the **ON / OFF** symbol in the display.



c) Press  to accept the new settings for this programmable timer.

The coffee brewer will now proceed to the next programmable timer (point h) until all 5 timers have been programmed. Pressing  at any point during the timer programming will interrupt this and only values, that have been accepted with  will be stored.

Adjusting time format:

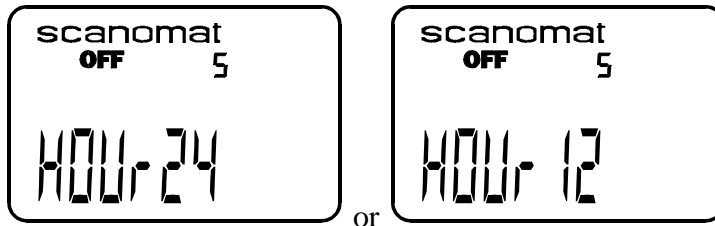
The coffee brewer can be set to run with 24 hour format or 12 hour format (Am/Pm). When all 5 programmable timers have been adjusted as described above, the display will show:



a) Press  and  to select between the 2 functions.

b) Press  to accept the new value.

Adjusting the active recipe version:

a) Press  while the SERVICE program is active.



The display will show:

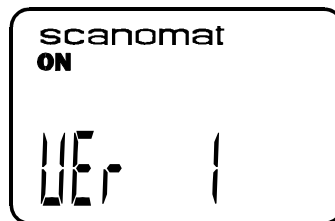

b) Press  and the display will show:



1 being the currently active recipe version.

c) Press  and  to change the active recipe version.

d) Press  to accept the new value.

There must be a recipe version programmed in the selected version if the coffee brewer is to work with this setting.

Service functions

All functions in this section requires, the coffee brewers SERVICE program is active. This is activated by pressing the  key positioned on the inside of the door of the coffee brewer. The display will show:

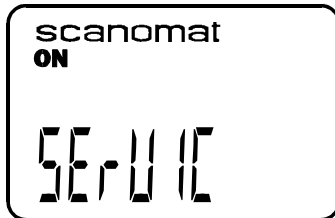

Note:

The coffee brewer can be set up to automatically leave the SERVICE program, if no key has been activated for a period of 15 seconds.

The coffee brewer can be set up in a way, that the  key is not active. In this case the SERVICE program is activated by pressing a code on the keyboard. This code is available from Your Scanomat dealer.

Reading out the counters:

The coffee brewer will count all the drinks dispensed. By carafe selections, the number of cups for each carafe will be counted. Reading out the counters is done as follows:

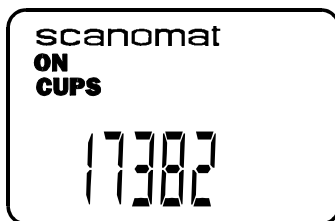

Press  while the SERVICE program is active and the display will show the total cup counter (example):



Pressing the individual selection keys will display the individual counters for these.

Pressing  will return to the SERVICE program.

Erasable counters:

The coffee brewer may be equipped with dual counters. In this case the one is Erasable, and can be used for periodic accounting and the not erasable as total counter for the coffee brewer. Reading out the erasable counters is done as described above by pressing , while the SERVICE is active, and the display will show the total number of cups taken since the counter was last reset. Pressing the individual selection keys will display the erasable counters for these. Pressing  will return to the SERVICE program.

Resetting counters

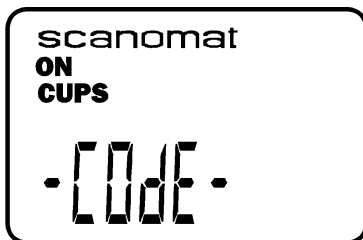

Pressing  while the erasable counters are on the display, will activate the resetting of these. To avoid accidental resetting, a code is required. The display will show the following while the speaker will beep continuously:



The code is 6 keys, that must be activated with a maximum of 1 second pause between 2 keys. Pressing  will return to the SERVICE program. If the correct code is entered, the counters will be reset and the display will show:



Reading out the not erasable counters.

With the erasable counters in the display - press , and the display will now show the total counter for the not erasable counters. The symbol **CUPS** will be flashing to indicate that it is the not erasable counters. Pressing the individual selection keys will display the not erasable counters for these. Pressing  will return to the SERVICE program.

Print out of the counters:

It is possible to print out the cup counters of the coffee brewer by means of a HP82240 printer using the infrared connection on the inside of the door of the coffee brewer.

a) Position the printer in a place where it can “see” the infrared window on the inside of the door. Maximum distance approximately 50 cm.

b) While the SERVICE program is active - press  keep this pressed and press simultaneously  and the display will show:

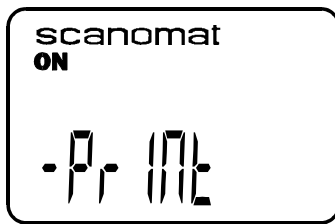

and the counters of the coffee brewer will be printed out. Selections with the counter value 0 will not be printed. Pressing  at any point will interrupt the print out.

Print out of the setting of the coffee brewer:

It is possible to print out the whole settings of the coffee brewer by means of a HP82240 printer using the infrared connection on the inside of the door of the coffee brewer.

a) Position the printer in a place where it can “see” the infrared window on the inside of the door. Maximum distance approximately 50 cm.

b) While the SERVICE program is active - press  keep this pressed and press simultaneously  and the display will show:

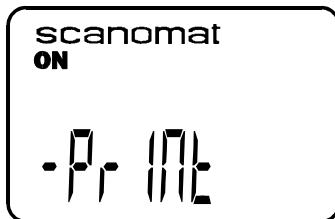

and the setting of the coffee brewer will be printed out. Pressing  at any point will interrupt the print out.

Product weighing:

It is possible to weigh the gram throw of the individual products in the individual selections. This is done by activating a function where only products will be dispensed by activating a selection key (no water or whipping). This function is useful for controlling that the coffee brewer actually dispenses the desired amount of each product in the individual selections after adjusting the cup sizes and the strength(s). To make an easy collection of the products, it is recommended, that the mixer system is removed during the process and the products can then easily be collected in a disposable cup.

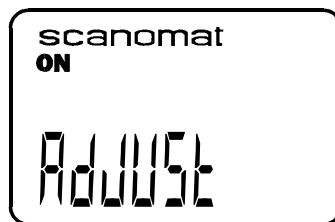

- a) Press  while the SERVICE program is active.

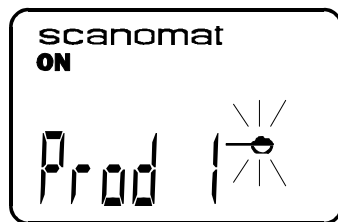

The display will show:

- b) Press  and the display will show:



This indicates, that the coffee brewer by pressing a selection key will dispense product number 1 for this drink. If the drink in question is a mixed drink the product number can be adjusted up and down respectively by pressing  and .

Pressing a selection key will now cause the coffee brewer to dispense one portion of the product number in the display for this drink. If nothing is dispensed, it is because, the product number is set higher than the number of products in this drink. For accurate weighing it is recommended, that at least 5 portions of each product is taken and then the average is calculated.

Pressing  will cause the coffee brewer to return to the SERVICE program.

Maintenance

Important: To maintain sanitary conditions it is of the utmost importance that all components that are in contact with the drinks are kept clean.

Important: Coffee brewers dispensing beverages must be manufactured, installed and operated in a way that leaves absolutely no risk of pollution or other depreciation of the beverages. According to directiv No. 93/43/EEC og 14/6-93 and directiv No. 96/3/EEC of 26/1-96.

Important: Do not sink the coffee brewer into water and do not use high pressure cleaner.

Note: A high quality of the daily maintenance secures a high level of hygiene.

Daily Maintenance:

Caution: Before starting the cleaning procedure make sure that the coffee brewer is switched off in order to avoid damages and injuries with hot water and rotating parts. Make sure to switch off the coffee brewer on the main switch (see point I on the General Drawing). Please note that only the low voltage control circuit will be cut off, the main voltage will not be cut off.

1. Rinse in hot water with a mild soap solution.
2. Switch off the main switch ("I") of the coffee brewer. Light and text in the display will disappear.
3. Dismount jet nozzle, "S", and clean by means of the cleaning brush.
4. Clean outlet tubes, "R", by means of the cleaning brush.
5. Dismount ingredient funnels, "B", and wash in hot water with a mild soap solution (dismount by lifting the hinges).
6. Dismount mixer bowls and whipper houses "C" and "D" by turning the whipper house "D" to the right and pulling out. Clean in hot water with a mild soap solution.
7. **Note:** Beware only to dismount the whipper blade, if it's strictly necessary, by means if there is dirt inside the silicone bellow or if the white teflon seal can't move freely forth and back on the shaft. **Note:** If the whipper blade, "O", is dismounted, please see to it that it is re-mounted correctly (the arrow must point

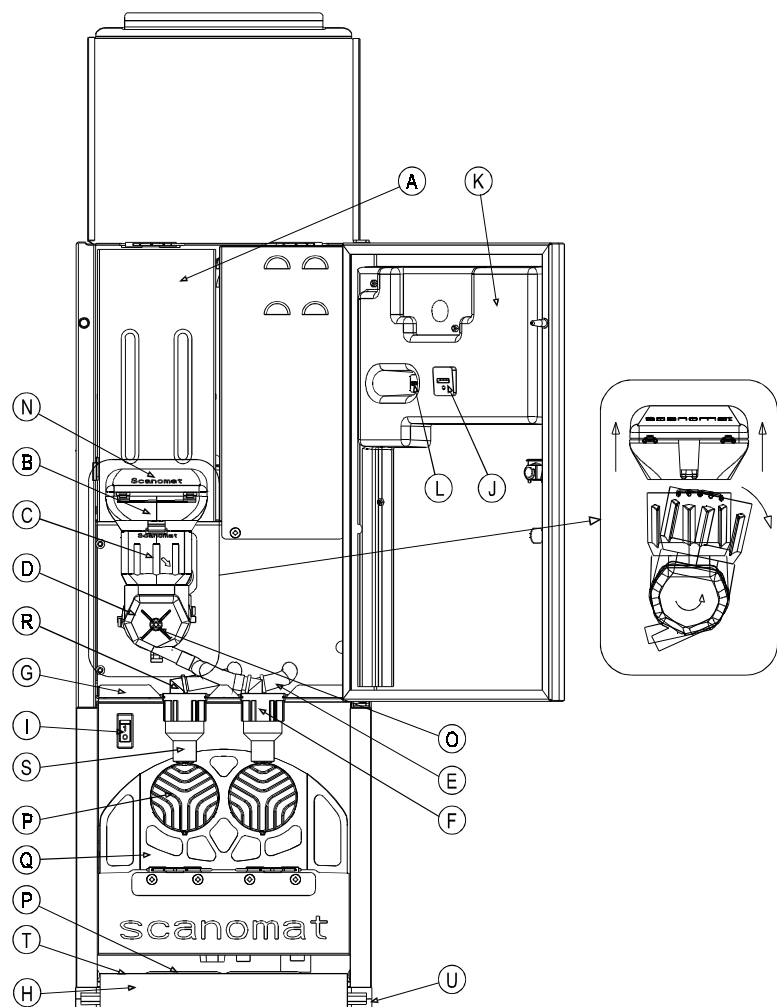

- towards the flat part of the shaft, and the blade must be pressed over the shaft till it clicks). **Note:** Beware not to damage the white teflon seal. It only may be cleaned with a soft brush.
8. Empty and wash drip tray "H" and mesh "T".
 9. Wash cabinet, door, whipper area and dispensing area. Use a light detergent solution and hot water.
 10. Re-mount whipper houses and ingredient funnels, "D" and "B". The funnels must be completely dry before re-mounting (see instruction on the inside of the door).
 11. Switch on the coffee brewer.
 12. Flush the brewing system:
 - a) Place a pot under the dispensing spouts.
 - b) Press the Service Switch on the inside of the door, the display will show "SERVIC".
 - c) Press "CLEAN".
 - d) When the flush programme has been carried out, press the Service Switch. It is possible to stop the flush programme at any time just by pressing "STOP".
 13. Fill the coffee brewer with ingredients for one day's consumption. It is of the utmost importance that you observe this recommendation as ingredients easily absorb moisture.
 14. Test the coffee brewer.

Preventive Maintenance

A preventive maintenance has to be carried out at fixed intervals depending on the performance of the coffee brewer and in which environment the coffee brewer is installed as well as the quality of the drinking water in the area.

- 1) Use hot water with a mild soap solution.
- 2) Empty the canisters.
- 3) Remove remnants, if any.
- 4) Dismount the ingredient throw auger by pulling out the two snap locks, thus it is possible to pull out the auger. Rinse auger and ingredient canister in the hot water with mild soap solution. Do not re-install the ingredient canister and auger until they are completely dry.
- 5) Re-mount the ingredient canisters and fill up with ingredients for one day's consumption. Please make sure that the canisters are completely dry before filling.

Note! We recommend that water is drawn off the coffee brewer and replaced by fresh water after holidays or weekends when the brewer has not been in operation for some time.

Trouble Shooting:

Problem	Possible Cause
No operation at all	Main switch (I) might be off
Coffee brewer only dispenses water	No ingredients in the canisters, Make sure the augers are turning when operating
A water tap symbol flashes in the display	Check that the water supply has been connected. Activate flush programme.
A thermometer appears in the display	Press the button on the back side of the coffee brewer
Clogged mixing bowl or whipper	Dismount and clean the mixing units (see "Daily Maintenance")
Dripping from outlet spouts	Activate flush programme a couple of times
Dripping from the overflow at the bottom of the coffee brewer	Activate flush programme a couple of times

Connection Chart Compact One