

scanomat

coffee solutions for more than 50 years

Users / Service manual Table Top Juicer



Preliminary edition

English edition EC

Version 1.01

Re-ordering no: x.....

Congratulations on your choice of Scanomat Table Top Juicer.

Should you have any questions regarding the equipment and the operation of it please do not hesitate to contact us.

We are convinced that you will be pleased with your choice!

Operation of the SCANOMAT juice machine.

The Scanomat Juice machines are high technology dispensers which by means of a micro processor controlled mixing process dispenses various first class quality drinks. Water is cooled down in the thermostatically controlled ice-bank cooler with automatic water inlet. The Ice-bank cooler has built-in safety switches and an overflow leading to the drip tray. By means of an special designed mixing device the various juice concentrates' are pumped from the bag in box to a mixer and here water is added.. It is possible to choose between cup and jug dispensing.

Important:

Warning:

Before cleaning, servicing etc. that require the opening of the front door, the switch situated in the delivery area must be switched off. The equipment has been switched off when the display light turns off.

Note:

Please be aware that the switch only disconnects control circuit, not the power supply.

Warning:

This appliance is not intended for use by persons (including children) with reduced physical sensory or mental capabilities, or lack of experience and knowledge, unless they have been given supervision or instruction concerning use of the appliance by a person responsible for their safety.

Children should be supervised to ensure that they do not play with the appliance.

Warning:

Access to the service area is restricted to persons having knowledge and practical experience of the appliance, in particular as far as safety and hygiene are concerned.

Note:

The new detachable hose set supplied with this appliance are to be used at installation, and old hoses are not to be reused.

Note:

Water supply hose sets shall comply with IEC 61770.

Warning:

This equipped might be using fresh juice. Fresh juice is a potential hazardous food, where the safety of the food depends upon the temperature and duration of store, as well as good cleaning and hygienic procedures (HACCP).

Technical specifications:	7
Installation:	8
Table layout (top view):	8
Water connection:	10
Maintenance:	11
Daily cleaning:	12
Preventive maintenance:	15
Trouble Shooting:	15
Operational procedures:	17
The keyboard:	17
Selection keys:	17
Preselection keys:.....	17
Navigation key:	17
The Display:.....	18
Turning the machine on and off:	18
Dispensing a single standard drink:	18
Preselections:	18
Dispensing carafes:	18
Dispensing PRIME selections:.....	19
The menu:	20
Disable keypad:.....	21
Reading out data from the machine:	21
Reading the cup counters:.....	21
Clearing the cup counters:	22
Adjusting the machine:	22
Adjusting cup sizes:.....	22
Adjusting drink strength:	23
Adjusting carafe:.....	24
Adjusting version:.....	24
Adjusting the watch:	25
Adjusting the timers:	25
Machine settings:	26
Key beep:.....	26
Child lock:	26
Fahrenheit:	26
Am / Pm time:.....	26
Display watch:	26
Automatic off:.....	27
Cup light:	27
Carafes:	27
Mugs:	27
Auto start:	27
Adjust lock:	27
Water tank:	27
Diagram:	29

Technical specifications:

Power supply:

Single phase 230 VAC, 1 Amp, with neutral and ground connection.

Dimensions:

Height: 810 mm.

Width: 465 mm.

Depth: 490 mm.

Ice-bank water tank:

4,5 L

Refrigerator gas: R134a, 0,075 kg.

Weight:

Gross: 45 kg.

Nett 42 kg.

Water connection:

Pressure: 300 kPa (3 Bar) – 600 kPa (6 Bar).

Environment:

Ambient operation temperature: 10-30° C.

Humidity: max. 90% RH.

Shelves / transportation:

Temperature: min 1° C.

Installation:

The following installations must be provided		
1.	Electrical single phase (optional)	230-240 VAC Single phase, 50 Hz, with ground connection, 200 W, 1 Amp
2.	Water Inlet	Pressure 3-6 bar, 300-600 kPa. Flow rate min. 5l./min. Temperature 5-10 °C
3.	Table	See diagram below

Table layout (top view):

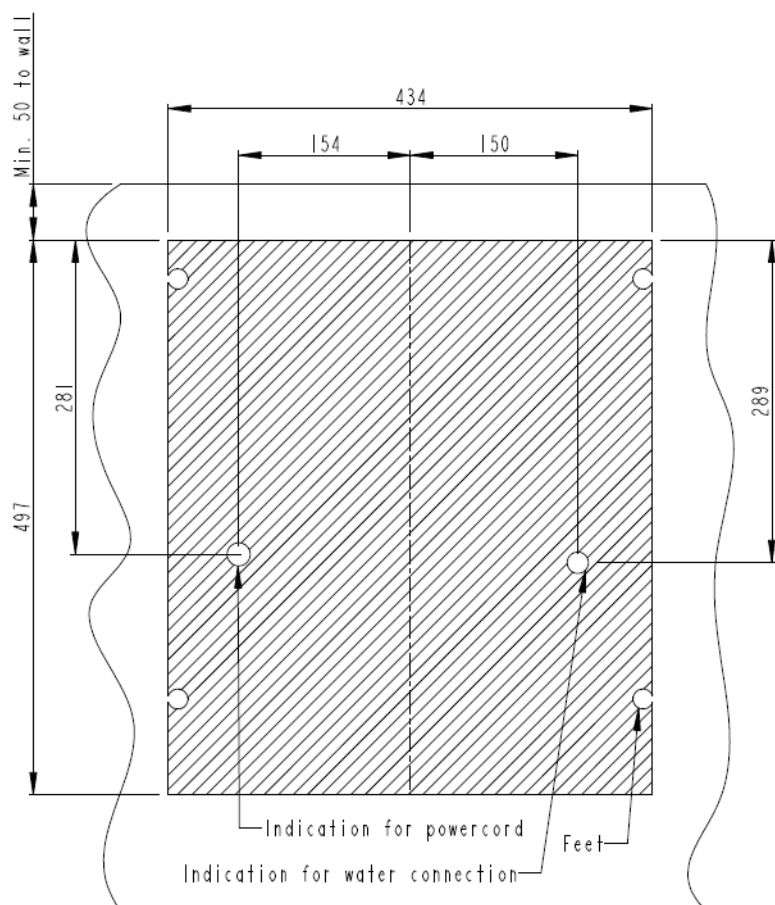

Service and repair is only to be carried out by service engineers educated by Scanomat.

The equipment is to be secured additionally in accordance with regulations.

The equipment must be earth connected (yellow/green conductor).

Note:

If the supply cable (power cord) has been damaged, please note that only a maintenance engineer recommended by the manufacturer is to renew it, as special tools are required.

Earth conductor: yellow/green
Neutral conductor: blue
Phase: brown or black

Note:

Place the equipment on a stable table, adjust the levelling feet until the brewer is level from front to back and side to side. Be certain all four levelling feet are in contact with the table to prevent rocking of the brewer. If there is a danger of the brewer falling down from the table it must be bolted down to the table top (unscrew the levelling feet and fasten by screwing through the table top).

Note:

The equipment requires ventilation. Therefore there must be a minimum of 50 mm from the backside, and from the left hand side of the brewer to the wall. The grating must be inspected frequently and vacuum-cleaned. If the installation site/environment is especially dusty there must be vacuum-cleaned each month.

Note:

Before connecting the equipment draw off some buckets of water by means of the hose (to clean the pipes and to avoid a disagreeable taste). This procedure is also recommended when the equipment has not been operating for some time.

Note:

We recommend that the equipment be switched on permanently due to the ventilation system among others.

Note:

The A-weighted noise pressure level of this appliance is less than 70 dB.

Water connection:

When the water supply is being established please make sure that the equipment is not situated on the rear end of the water supply system to ensure continuous supply of fresh water.

1. Connect the equipment to the cold water line, which is equipped with an adjustable check valve (1/2" external screw thread). Before connecting the equipment draw off some buckets of water to clean the pipes. If the water is not good quality we recommend that a Scanomat water filter is mounted.
2. Fasten the hose nipple to the valve
3. Turn on the water and make sure that all joints and connections are tight.

Note:

After long periods of inactivity (holidays or weekends) when the equipment has not been in operation for some time the water will lose its quality, therefore we recommend activating the "clean programme", perhaps a couple of times, in order to get fresh water.

It is important that the inlet water supply is a primary supply with its own 'stopcock' this is to ensure that during daily operation there is a constant water pressure at the inlet.

Maintenance:**General Drawing**

- A Door
- B Mixers
- C Outlet tubes
- D Bag in box juice
- E Flow regulator
- F Temperature setting
- G Cooling exhaust
- H Juice connector
- I On / off switch
- J Fuse
- K Cup holder
- L Drip tray
- M Leveling legs

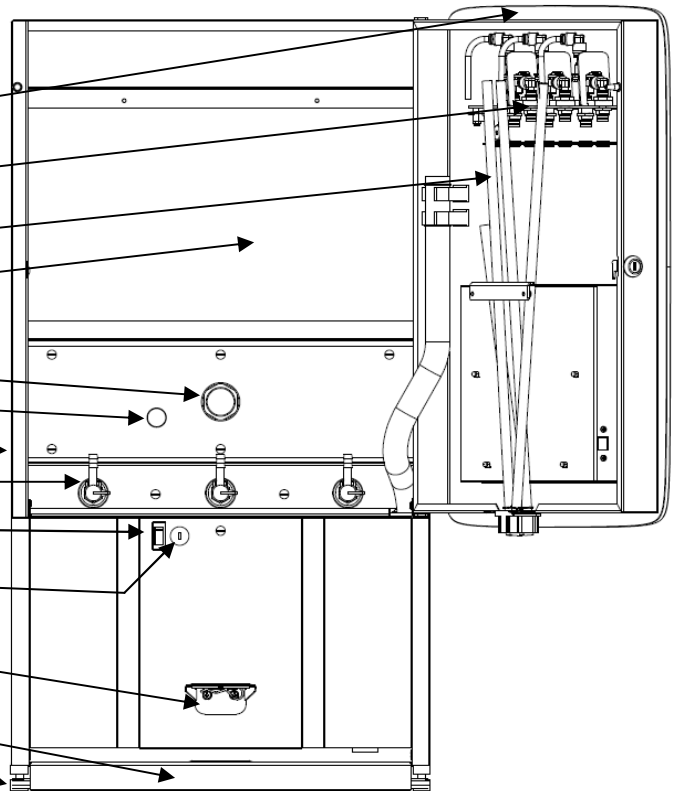
**Important:**

To maintain the high drink quality and efficient operating conditions it is of the utmost importance that all components that are in contact with the drinks are kept clean.

Important:

Machines dispensing beverages must be manufactured, installed and operated in a way that leaves absolutely no risk of impairing or ruining the beverages. All operations must follow the HACCP regulation.

Important:

Do not immerse the equipment into water and do not use high pressure cleaner

Note:

A high degree of frequent daily maintenance secures a high level of trouble free operation of the equipment.

Daily cleaning:

Caution: Before starting the cleaning procedure make sure that the equipment is switched off in order to avoid damages and injuries with electrical parts. Make sure to switch the machine off at the machine ON/OFF switch (see point C on the General Drawing). Please note that only the low voltage control circuit will be cut off by this switch, if the internal covers are removed there will still be mains voltage to the required circuits, compressors etc.

Cleaning:

Start preparing rinsing agent: Fill the rinse bucket with 2 liters of hot water, and add two cleaning tablets. When dissolved the rinsing agent is ready. Place the rinse bucket on top of the machine, with the outlet tube pointing down.

Close juice taps (clockwise)



Connect the clean connectors and open the taps.



Press the grey lock and remove the tubes.



Release the lock on the mixers.



Take out the mixers.



Turn the upper part clockwise, pull apart, and clean in hot water. Clean holes with the small brush.



Clean the connectors with a wet cloth.



Lift the mixers out from the connectors.



Push the parts together and turn the upper part counter clockwise.

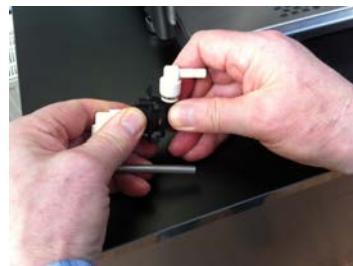

Lift outlet tube locking lever.



Lift out the tubes and clean inside.



Refit the tubes and mixers.



Start the cleaning program by pressing YES and CLEAN.



You are able to stop the cleaning program by pressing 2nd from ls.



Close the taps and remove the Connectors.



Fill rinse bucket with 2 liters of clean water, and place the rinse bucket on top of the machine.

Reconnect the cleaning connectors and open the taps.



Press YES + CLEAN for starting the clean program.



Close the taps and remove the cleaning connectors



Remove the drip tray and clean.



Replace the drip tray, juice connectors, and open the taps.



When pressing the prime key, squish the top end of the tube and push downwards to lead the concentrate to the pump.



Test all drinks and, if the taste is not satisfactory make a Brix test (see Brix scheme). Make adjustments if necessary.

Preventive maintenance:

The whole machine are to be cleaned at regular intervals depending on the performance, usage and location.

- 1) Use hot water with a mild soap solution
- 2) Remove bag in box's. Remember to close the taps.
- 3) Remove mixers and outlet tubes, and remove remnants, if any.
- 4) Clean in soapy water.
- 5) Re-mount the mixers and outlet tubes place the bag in box's, and open the valves.
- 6) Switch on the machine and test the drinks. Make Brix test on all selections (see suppliers Brix scheme).
- 7) Remove the drip tray and clean in soapy water.
- 8) Clean cooling exhaust with a vacuum cleaner.

Trouble Shooting:

<u>Problem</u>	<u>Possible cause / solution</u>
No operation at all	Main switch (I) may be off. Check fuse (J). Check light in display.
Only water is dispensed	Juice concentrate Bag In Box Empty. Fit new Bag in Box. Juice pump full of air bobbles. Press the tube from the Bag In Box, for feeding the pump. Run a complete cleaning program (see cleaning procedure page 14).
No water, - only juice concentrate	Ice-bank frozen. Switch of the water cooler and wait for 4-6 hours, before switching on again. Check the cooler thermostat setting (5,5). Check if water supply is open.
Drinks not cold enough	Too many vends in a short time. Wait for 5-10 min. for the cooling system to recover. Ventilation not sufficient. Check ventilation to the cooling unit. Check if the cooling condenser (G) at the left hand side is clean (clean with vacuum cleaner).

Drinks not strong enough

Check Brix adjustment.

Display shows OVERLOAD

One of the pump outputs are overloaded.

Operational procedures:

The keyboard:

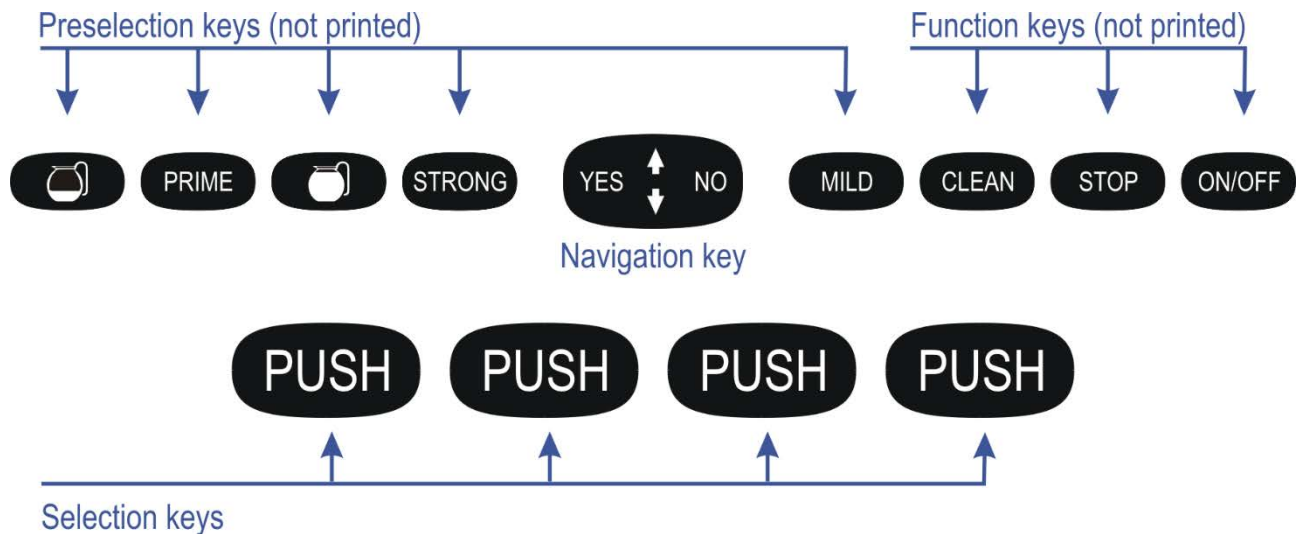

Selection keys:

The selection keys will, when the machine is operational, meaning water in the tank and warm enough dispense the selected drink. Place the cup at the appropriate position. If more positions, the right one, will be indicated on the front of the machine.

Preselection keys:

These keys will activate a pre selection to the next drink. The preselection buttons may differ from machine to machine and in some machines they may not all be active.

There is a time out of 15 seconds on all preselections.

Multiple preselections are allowed e.g. strong, carafe

Pressing NO or STOP will cancel all preselections

Function keys:

These keys have special functions: CLEAN, STOP and ON/OFF

Navigation key:

The navigation key is used to access the menu and programming system of your Juicer. When in adjust mode the UP and DOWN keys have an automatic repeat function. This is activated by holding the key instead of just giving a single press. In that case the adjustment will “run” instead of just step.

The Display:



The display will show relevant information in clear text, and in symbols.

Turning the machine on and off:

There are 2 ways of turning the machine off. Either by pressing and holding the ON/OFF button for 2 seconds, or by switching the power off completely by activating the mechanical switch in the dispensing area.

Using the first option, will keep the electronic board running with a very low power consumption (less than 1 watt). As the internal watch in the machine is dependent on power, always select this way to turn the machine off, if you are using this. When the machine is OFF, the light in the display will be gone, and only the Scanomat logo will be active.

Switching back on is done by pressing the ON/OFF button, or if this setting is active, by pressing a selection button

Dispensing a single standard drink:

Place a cup under the proper dispensing outlet and press the selection button. If more than one outlet is available, a graphic on the front of the machine will show which selections correspond with which outlets. While brewing the display will show the name of the selected drink



Pressing STOP will interrupt the dispensing

Preselections:

Apart from the direct selection keys, a number of pre-selection possibilities are available, these will be explained in detail hereafter. The pre-selections can be used more than one at a time, for example a carafe of PRIME ORANGE is possible, if the machine has both of these options available. To cancel any pre-selection, press STOP or NO. All the pre-selections are controlled by a timer meaning that if no selections is made within 15 seconds after the pre-selection, this will time out. After the drink is dispensed, all pre-selections are reset.

Dispensing carafes:

Making a carafe of any product in this machine is always carried out as making a number of cups of the selection in question.

Place a carafe under the proper dispensing outlet. If more than one outlet is available, a graphic on the front of the machine will show which selections correspond with which outlets. Press either of the carafe keys, the display will show:



2 being the number of cups programmed for the carafe key. Size of the carafe can be adjusted by pressing ↑ or ↓ or by repeating the carafe key press.

While brewing the display will show the name of the selected drink and the number of cups left for this carafe.



Pressing STOP or NO any time during a carafe brew will terminate the dispensing

Dispensing PRIME selections:

The unit is equipped with a PRIME function. This is designed to prime the pumps and mixing system after either change of concentrate box or after a CLEAN procedure. Press the PRIME pre-selection and the display will show



Pressing a selection key will now PRIME the corresponding selection by running the dose motor at full speed for a short period.

Service key mode:

The machine **may** be locked out from normal use of the programming / adjusting features. If this is the case, open this pressing the small carafe, the prime and the stop key simultaneously. Display will briefly show:



The service key mode will automatically time out after 30 seconds, if the machine is left untouched.

The menu:

Using the navigation button, the menu system for accessing all audit data, adjustments and settings of the machine can be reached. Pressing the arrow up and down, YES to enter a function, NO to go back one step, does the navigation through the different menus.

Please note that not all menu points described in this manual is available in all machines, as this can vary with different configurations.

The following sketch shows an overview of the complete menu system.

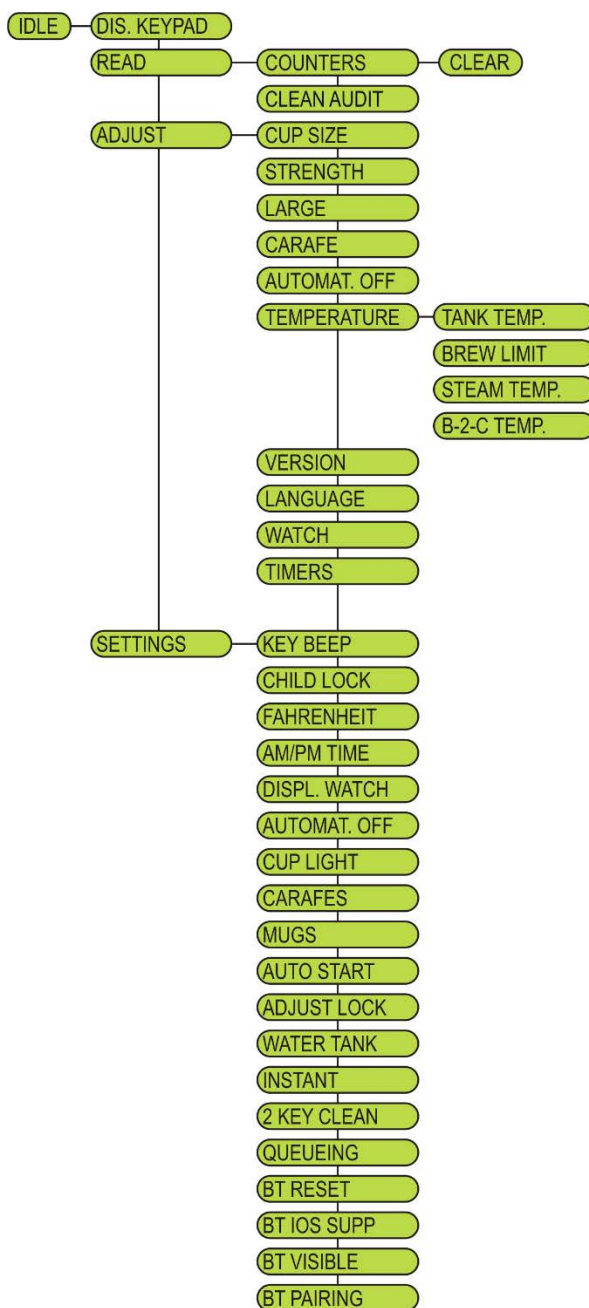

Disable keypad:

A function available to lock the keypad completely. Normally only used for machines with combined keypad and Tablet / SmartPhone operation. Re-enabling the keypad is done by simultaneously pressing **STRONG** and **YES**.

Reading out data from the machine:

Some data can be read out your coffee machine directly from the keyboard. Number of possibilities may vary from configuration of your machine. Press the navigation button **UP** until the following appears:



Press navigation button **YES**, and the first adjustable parameter will appear in the display. Pressing **UP** and **DOWN** will scroll between the possibilities.

Reading the cup counters:

Enter the read menu as described above, scroll to:



Press **YES**, and the display will show:

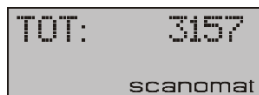

3157 being the total number of cups dispensed, including any cups, which were parts of a carafe. When the above display is shown, the individual cup counters for each selection can be read by pressing the selection keys accordingly.

Clearing the cup counters:

Depending of the configuration of your machine, it may be possible to clear the cup counters (set them all to 0).

Clearing the counters also requires the machine to be in SERVICE KEY mode.

Use the procedure above to read out the total cup counter. When the total is in the display, press CLEAN, and the display will show:

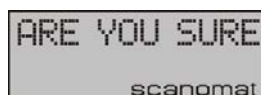

Adjusting the machine:

A lot of different parameters in the machine can be adjusted directly from the keyboard. Press the navigation button UP until following appears:



Press navigation button YES, and the first adjustable parameter will appear in the display. Pressing UP and DOWN will scroll between the possibilities.

Adjusting cup sizes:

The cup size can be adjusted for each selection independently. The pre-programmed cup size is referred to as 100% and not as a fixed volume, as the size may differ from selection to selection.

Enter the adjust menu as described above, scroll to:



Press YES and the display shows:



Press a selection button and the display shows:

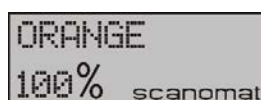

Press UP or DOWN to reach the desired level and press YES to confirm. The machine will then return to:



and a new selection can be adjusted or the function can be abandoned by pressing NO.

Adjusting drink strength:

The drink strength can be adjusted for each product for each selection independently. The pre-programmed strength is referred to as 100% and not as a fixed amount, as it differs from selection to selection.

Enter the adjust menu as described above, scroll to:



Press YES and the display shows:



Press a selection button and the display shows (example)

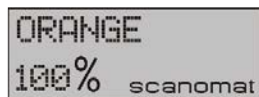

This is pre-programmed amount of ORANGE CONCENTRATE in the selected drink. Press UP or DOWN to reach the desired value and YES to confirm. If the selected drink has more than one adjustable ingredient, the procedure will be repeated. When no more adjustable ingredients in the current selection, the display will return to:



Either select a new drink to adjust, or press NO to go back.

Adjusting carafe:

The carafe function is a way to make number of cups of a. selection. Depending on the configuration of your machine, it may have 1, 2 or 3 different carafe sizes (small, medium and large).

Note that if the carafe function is not active in your machine, this parameter will not appear in the adjust menu.

Enter the adjust menu as described and scroll to:



Press YES and the display will show:



S indicating the small carafe. Press UP or DOWN to reach the desired value and YES to confirm.

This way all 3 possible carafe sizes can be adjusted.

Adjusting version:

Your coffee machine MAY be programmed with more than one set (version) of recipes. If this is the case, you can switch between these different set by adjusting the active version.

Enter the adjust menu as described and scroll to:



Press YES, and the display will show:



Press UP or DOWN to reach the desired value and YES to confirm. If you adjust the version to a position in which no recipes are programmed into your machine, the result will be the display showing:

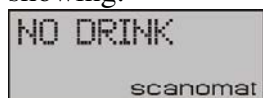

When ever a selection key is pressed.

Adjusting the watch:

Your coffee machine is equipped with a watch. This watch has a battery backup that will keep it running for a minimum of 48 hours even if the mains is cut off. If you want to maintain the watch correct, you should only switch the machine off using the front ON/OFF key.

Enter the adjust menu as described and press UP or DOWN until the display shows:



Press Yes, and the display will show the current time with the minutes blinking. Adjust these by pressing UP or DOWN and YES to confirm. Adjust the hours in the same way.

Adjusting the timers:

Your juice machine is equipped with 4 programmable timers. These are designed to power the machine down in certain periods. The timers are all 24 hour based, meaning that not weekly or monthly functions are available.

Enter the adjust menu as described and press UP or DOWN until the display shows:

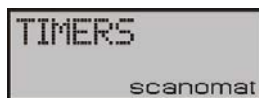

Press YES, and the display will show (example)

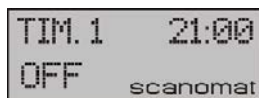

With the minutes blinking. OFF indicating that this is the time where your juice machine will power off. Use the UP, DOWN and YES to adjust this time, and thereafter repeat the procedure with the ON time. After that, you will get the option to activate or deactivate the timer in question.

Example: If you want your juice machine to power down between 23:00 in the evening and 6:00 in the morning, adjust the timer1 to OFF : 23:00 and ON : 6:00 and set it to activated.

If you are using more than one active timer, make sure that the timer periods are not overlapping.

You do not need to go through all timer adjustment to set just one. When finished with one timer, simply press NO to go back out.

Machine settings:

The machine settings are a lot of different parameters, which can be selected or deselected by you. . Press the navigation button UP or DOWN until following appears:



Press YES and the display will show:



Use UP and DOWN to scroll through all the different settings and press YES to change the setting currently in the display and following will appear (example):



Press YES and the current status will appear in the lower line of the display. Use UP or DOWN to alter this and YES to confirm.

NOTE: Not all settings may be relevant to all machine types.

Key beep:

Is simply the response sound when you press a button on the keyboard.

Child lock:

Is a function to prevent children from unintentionally activating your juice machine. If this function is active, taking a selection is done by first pressing YES, and while holding this pressed, pressing the selection button. Pressing the selection button alone in this mode will cause an alarm, and the display will show:



Fahrenheit:

Is an option to have the temperature in the boiler displayed in Fahrenheit en stead of Celsius (or centigrade).

Am / Pm time:

Is selecting between the Am / Pm way of showing the time and the 24 hour system.

Display watch:

Is choosing whether the watch should appear in the display, whenever your juice machine is in idle mode.

Automatic off:

If this setting is activated, your juice machine will automatically turn itself off, if has been inactive for 15 minutes.

Cup light:

Your juice machine may be equipped with a light illuminating the dispensed drinks. If this is the case, it can be activated or deactivated by means of this function.

Carafes:

If your machine does not have the direct carafe buttons on the keyboard, the menu activated carafe function can be activated or deactivated by this function.

NOTE: If your machine is with the SERVICE KEY SYSTEME active, this CARAFES function determines whether the carafes keys should be available for self service customers or not:

If carafes = OFF, carafe keys will only be available in SERVICE KEY MODE

Else they will be available always.

Mugs:

If your machine does not have the direct large button on the keyboard, the menu activated large function can be activated or deactivated by this function.

Auto start:

If this function is active, pressing a selection button when your machine is off will cause it to turn on, heat up, and dispense the selection when it is ready.

Adjust lock:

If adjust lock is activated, the menu system is locked out, so only carafe, large and read are available. To enter the rest of the menu, the machine must be in SERVICE KEY mode. Note that setting this function to active is irreversible, unless you have the option to go into SERVICE KEY mode.

Water tank:

Your juice machine may be equipped with as well external water supply as an internal cold-water reservoir. If this is the case, selecting between these 2 options is done by this function.

Instant:

Not relevant for juice machine.

2 key clean:

If set to ON, the clean functions is activated by simultaneously pressing YES and CLEAN.

Queuing:

If set to ON the next drink can be ordered while the current one is being dispensed. The next drink will then start immediately after the first one.

BT reset:

A function to reset the BlueTooth® module. **You should carry this function out after consulting a Scanomat technician!**

BT iOs Support:

Must be set to ON if running with Apple devices on the BlueTooth®

BT Visible:

Must be set to ON, if the machine shall appear as a potential BlueTooth® device on nearby devices with BlueTooth®.

BT Pairing:

Must be set to ON, if new devices should be able to pair their BlueTooth® with the one of the Scanomat machine.

Diagram:

